

Mojo Barriers is the leading international supplier of stage barrier systems, setting the industry standards for live events.

Products: The favourite among event organisers looking for a safe, sustainable and cost effective system, Mojo's continual investment in R&D results in proprietary barriers which are proven, adaptable and reliable. As well as aluminium stage barriers Mojo has a vast portfolio of other innovative products designed for use at outdoor and indoor events including turnstile systems, line up gates, bar barriers and a range of accessories.

**THE MOJO
BARRIERS®**
www.mojobarriers.com

Crowd management: Mojo combines these independently tested products with an expansive knowledge of crowd management and crowd control, and experienced project managers. Taking into consideration a wide variety of factors, Mojo creates bespoke configurations designed with audience, guest and crew safety as the highest priority.

Offering an international network, combined with local service, Mojo Barriers has been the trusted global stage barrier resource for over twenty years.

FIXED CORNERS: 22.5° CORNER

TECHNICAL SPECS

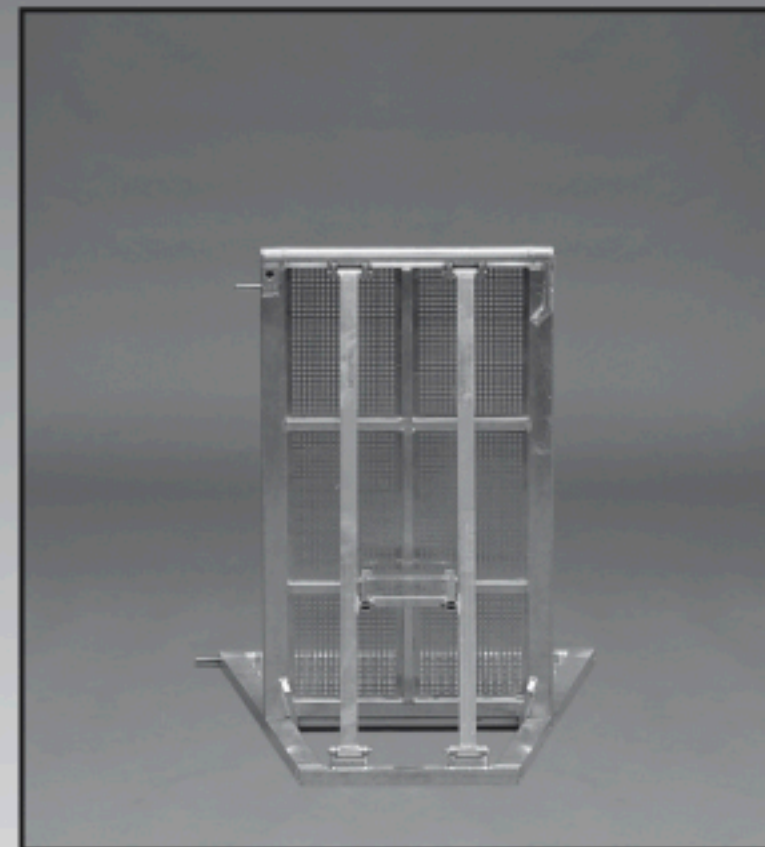
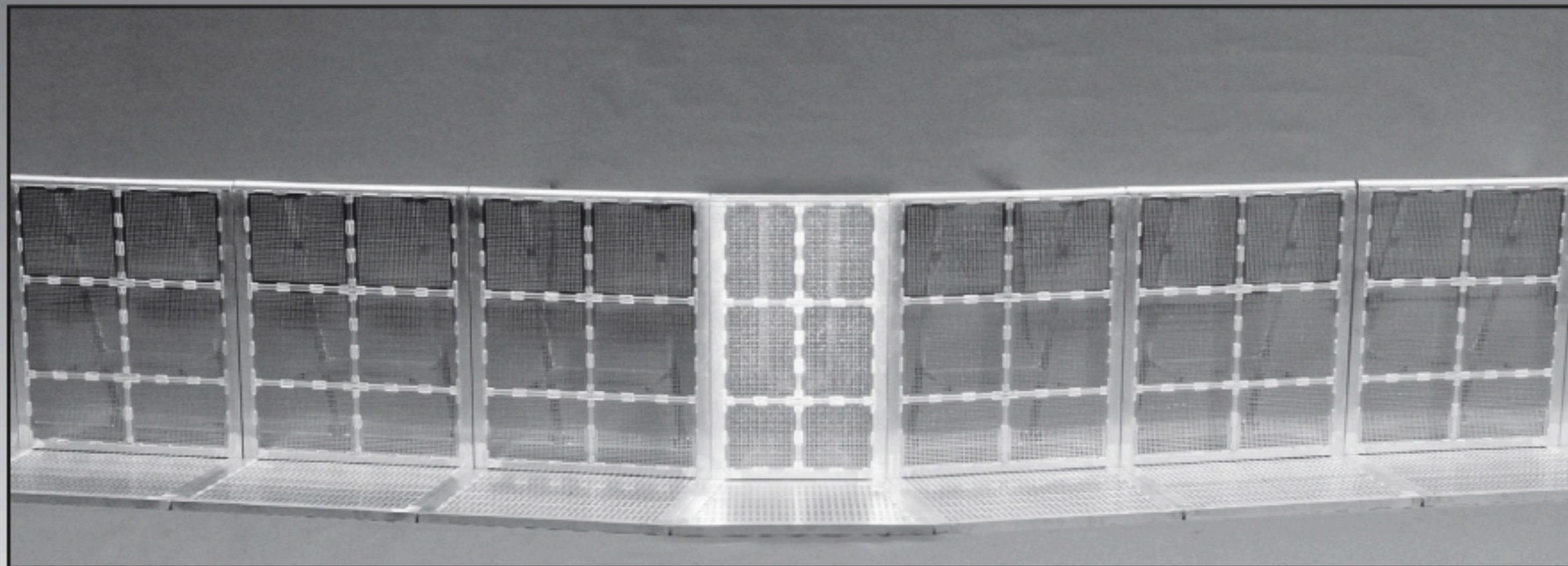

22.5° POSITIVE CORNER (PINK)

A fixed corner section of 22.5° with full floorplate, double brace and small rear step. 'Positive' means moving away from the crowd, usually towards the stage. Nicknamed Pink as its colour mark is pink for easy recognition on site by anyone installing the equipment.

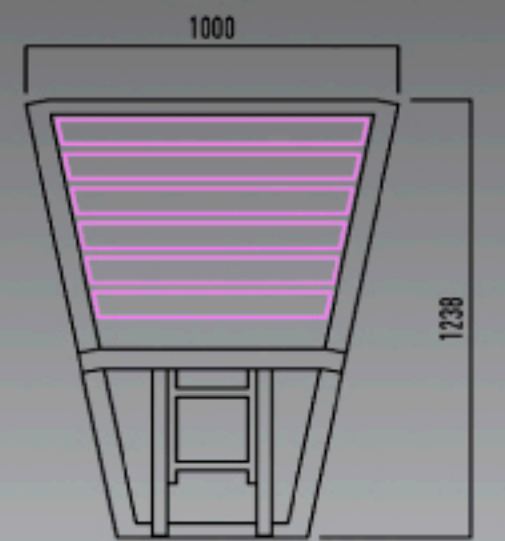
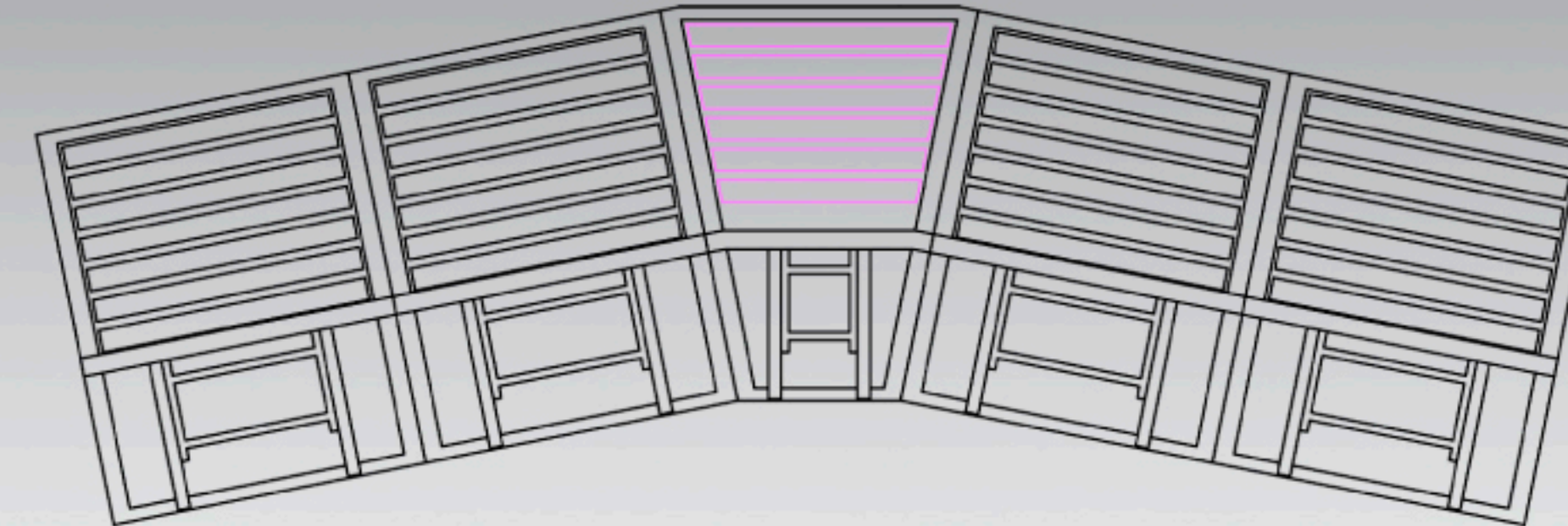

Both Pink and White have complete floorplates and braces, ensuring continuous strength of the barrier lines. Furthermore, they can easily be used in combination with other corner sections to design wide and smooth shapes. Colours are present on the braces to make recognition easy. Typical usage would be around catwalks and thrusts in front of a stage.

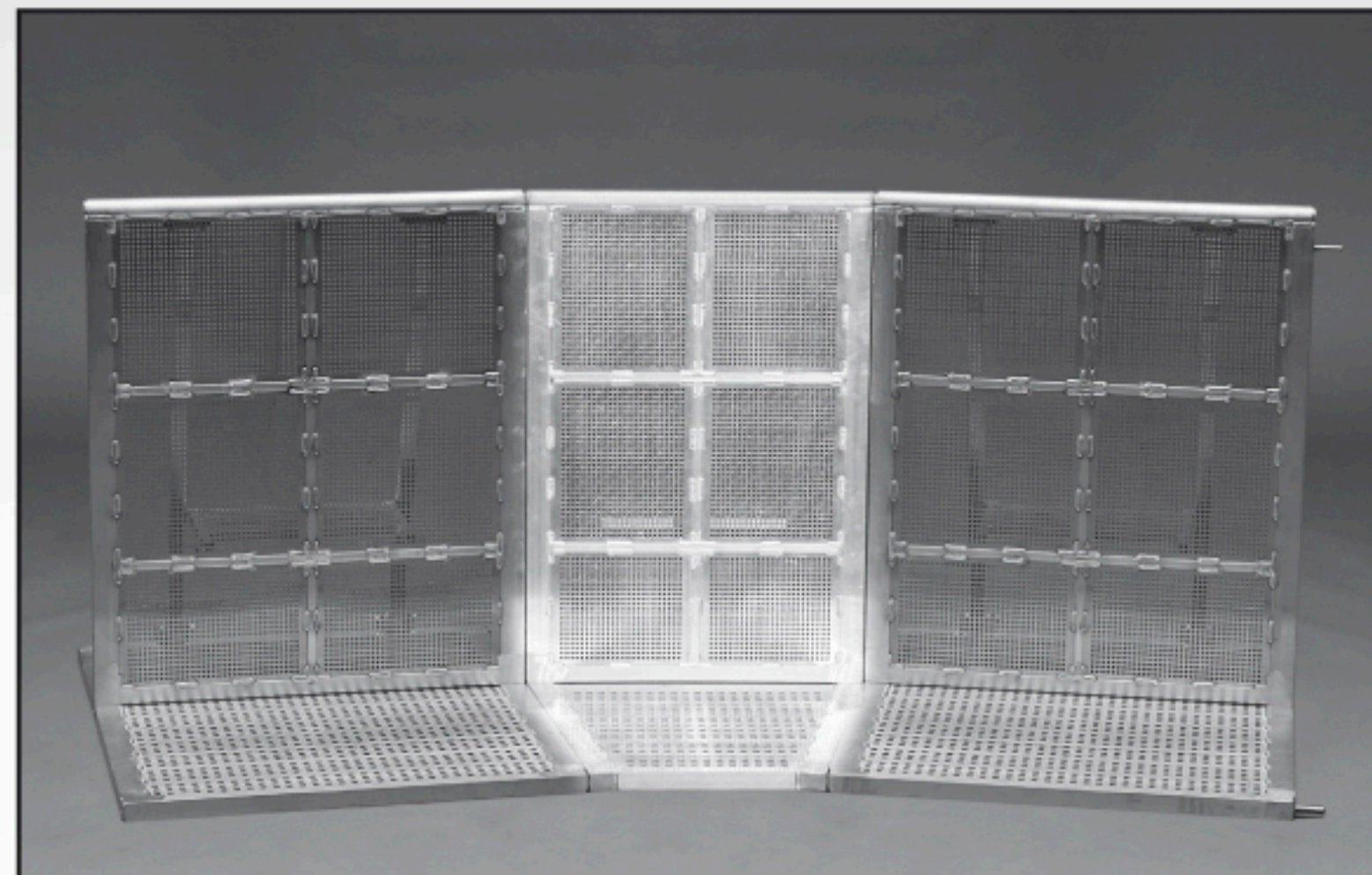

22.5° NEGATIVE CORNER (WHITE)

The direct opposite of Pink is the fixed negative 22.5° corner section with a full floorplate, double brace and rear step. 'Negative' means moving towards the crowd, usually away from the stage. Nicknamed White for its white colour mark for easy recognition.

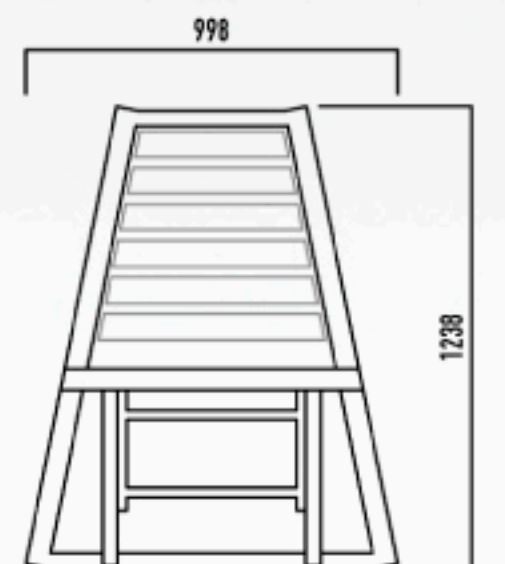
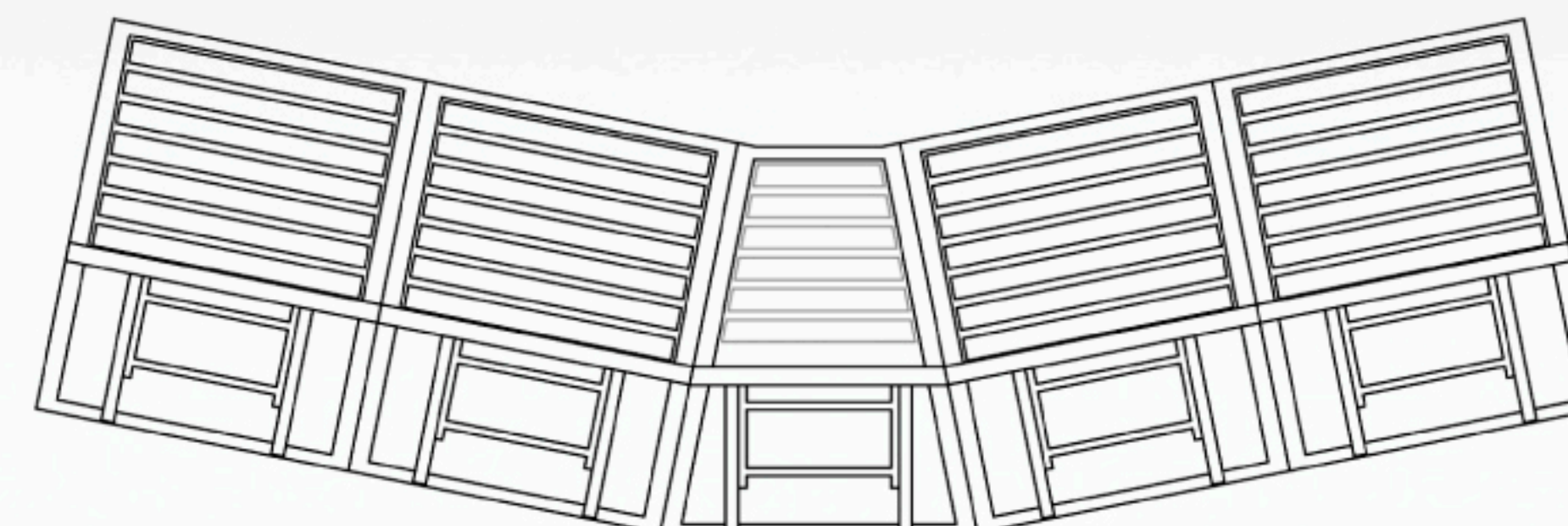

- Same material specifications and looks similar to the straight barrier
- Fixed angle of 22.5°
- Positive corner = Pink
- Negative corner = White
- Both with full floorplate and braces
- Rear step on both White and Pink
- Strength contained by floorplate coverage and braces
- Connects to adjoining section by one single bolt
- Also available with black upright
- Use in high crowd pressure areas: ●●●●●

WORLDWIDE CROWD CONTROL SOLUTIONS

• Holland/Belgium/Luxemburg
Veldzigt 3
3454 PW de Meern, NL

Phone: +31 30 242 82 00
Fax: +31 30 242 82 09
Email: info.nl@mojobarriers.com

• United Kingdom
Patch Park Farm, Ongar Road
Abridge, Essex RM4 1AA, UK

Phone: +44 1708 687 440
Fax: +44 1708 687 441
Email: info.uk@mojobarriers.com

• North America
181 East Stiegel Street
Manheim, PA 17545, USA

Phone: +1 717 664 0158
Fax: +1 717 664 0532
Email: info.us@mojobarriers.com

• International
Veldzigt 3
3454 PW de Meern, NL

Phone: +31 30 242 82 00
Fax: +31 30 242 82 09
Email: info.int@mojobarriers.com